

TWO PORT PETITE KVM SWITCH



USER MANUAL

CS-62U

Read this guide thoroughly and follow the installation and operation procedures carefully in order to prevent any damage to the units and/or any devices that connect to them.

This package contains:

- ◆ 1 CS-62U USB Two Port KVM Switch with Attached Cables
- ◆ 1 User Manual
- ◆ 1 Quick Start Guide

If anything is damaged or missing, contact your dealer.

© Copyright 2003 ATEN® International Co., Ltd.

Manual Part No. PAPE - 1237-100

Printed in Taiwan 10/2003

All brand names and trademarks are the registered property of their respective owners.

Note: This equipment has been tested and found to comply with the limits for a Class B digital device, pursuant to Part 15 of the FCC Rules. These limits are designed to provide reasonable protection against harmful interference in a residential installation. This equipment generates, uses and can radiate radio frequency energy, and if not installed and used in accordance with the instruction manual, may cause interference to radio communications. However, there is no guarantee that interference will not occur in a particular installation. If this equipment does cause harmful interference to radio or television reception, which can be determined by turning the equipment off and on, the user is encouraged to try to correct the interference by one or more of the following measures:

- ◆ Reorient or relocate the receiving antenna;
- ◆ Increase the separation between the equipment and receiver;
- ◆ Connect the equipment into an outlet on a circuit different from that which the receiver is connected;
- ◆ Consult the dealer or an experienced radio/television technician for help.



OVERVIEW

The CS-62U USB Petite KVM Switch is a control unit that allows access to two computer systems from a single console (keyboard, monitor, and mouse). Before the development of the CS-62U, the only way to control multiple computer configurations from a single console was through a complex and costly network system. Now, with the CS-62U, you can easily access two computers in a cost effective manner.

The CS-62U improves on previous models by transferring keyboard and mouse data to the computers via the faster, more reliable USB bus rather than the traditional PS/2 connection. In addition, its amazingly small desktop footprint plus molded-in custom KVM cables provide a hassle-free installation and a neat and tidy workspace.

Recognizing the increased importance of sound in the computing environment, the CS-62U provides USB multimedia keyboard support, and is speaker enabled. You can listen to the audio output of both computers (one-at-a-time) on a single set of speakers.

Setup is fast and easy; plugging cables into their appropriate ports is all that is entailed. There is no software to configure, no installation routines, and no incompatibility problems. Since the CS-62U intercepts keyboard input directly, it works on any hardware platform and with all operating systems. The KVM focus is toggled between the computers by means of simple Hot Key combinations entered from the keyboard.

There is no better way to save time and money than with a CS-62U USB Mini-KVM Switch installation. By allowing a single console to manage both computers, the CS-62U eliminates the expense of purchasing a separate keyboard, monitor, and mouse for each. Additionally, it saves all the extra space they would take up, and eliminates the inconvenience and wasted effort involved in constantly having to move from one computer to the other.

FEATURES

- ◆ One console (VGA, SVGA or Multisync monitor plus a USB keyboard and USB mouse) controls two computers
- ◆ Compact, small footprint, design features two molded-in KVM (keyboard, video, mouse) cables
- ◆ Easy to install - no software required - connecting cables to the computers is all it takes
- ◆ Easy to operate - computer selection via hotkeys - auto scan function to monitor computer operation
- ◆ Keyboard and mouse emulation - computers boot even when the console focus is elsewhere
- ◆ Hot pluggable - add or remove computers for easy maintenance
- ◆ Power on detection - automatically switches to the first powered on port
- ◆ Caps Lock, Num Lock, and Scroll Lock states are saved and restored when switching
- ◆ LED display for easy status monitoring
- ◆ Hotkey selection for OS and keyboard language
- ◆ Supports multimedia USB keyboards
- ◆ Supports Logitech and Microsoft wireless keyboards and mice
- ◆ Supports 4 and 5 button mice and the scrolling wheel on most mice*
- ◆ Superior video quality - composite sync video support - resolutions of up to 2048 x 1536; DDC2B
- ◆ Speaker enabled for audio sharing
- ◆ Supports Windows 98SE or higher, Mac OS 8.6 or higher, Sun Solaris 8 or higher and Linux RedHat 7.1 or higher
- ◆ Non-powered

* A mouse driver installed with the operating system is required for the 4th and 5th button functions.

HARDWARE REQUIREMENTS

CONSOLE

- ◆ A VGA, SVGA, or Multisync monitor capable of the highest resolution that you will be using on any computer in the installation
- ◆ A USB Keyboard
- ◆ A USB Mouse

COMPUTERS

The following equipment must be installed on each computer that is to be connected to the system:

- ◆ A VGA, SVGA or Multisync card.
- ◆ A USB type A port

CABLES

For optimum signal integrity and to simplify the layout, two high-quality 3-in-1 CS Custom KVM cables have been designed into the CS-62U. There is no need for a separate cable purchase.

FRONT VIEW

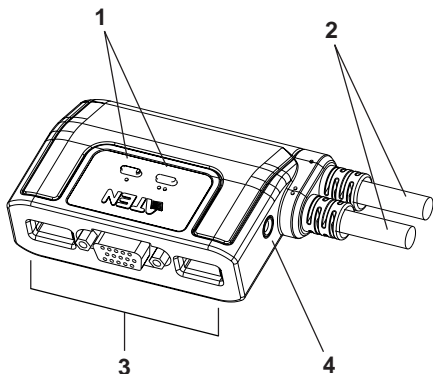

1. Port LEDs

A LED lights to indicate its corresponding port is the one that has the KVM focus. The LED that has one dot represents Port 1; the LED with two dots represents Port 2.

Depending on the port's status, the LED may flash according to a specific pattern (see the *LED Display Table*, p. 15, for details).

2. KVM Cables

These 3-in-1 cables connect to the USB, video, and audio ports on the computers you are installing.

The cable with one dot at its base is the Port 1 cable; the cable with two dots at its base is the Port 2 cable.

3. Console Ports

Your keyboard, monitor, and mouse plug in here.

4. Speaker Jack

Your cable from your speakers plugs in here.

INSTALLATION



1. Before you begin, make sure that power to all the devices you will be connecting up have been turned off. You must unplug the power cords of any computers that have the *Keyboard Power On* function. Otherwise, the switch will receive power from the computer.
2. To prevent damage to your installation due to ground potential difference, make sure that all devices on the installation are properly grounded.

Refer to the Installation diagram on the next page as you perform the following steps:

1. Plug your keyboard, monitor, mouse, into their respective ports on the CS-62U. The keyboard and mouse ports are labeled with an icon to indicate which is which.
2. Plug your speakers into the speaker jack on the CS-62U.
3. Plug the USB, video, and speaker connectors of the attached KVM cables into their respective ports on the computers you are installing.

Note: The computer attached to the cable with one dot at its base is the Port 1 computer; the computer attached to the cable with two dots at its base is the Port 2 computer (see p. 8 for hotkey port selection).

4. Turn on the power to the computers.

Note: The CS-62U's Power On default is to link to the first computer you turn on.

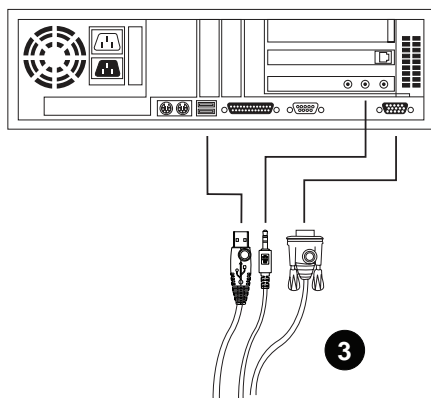
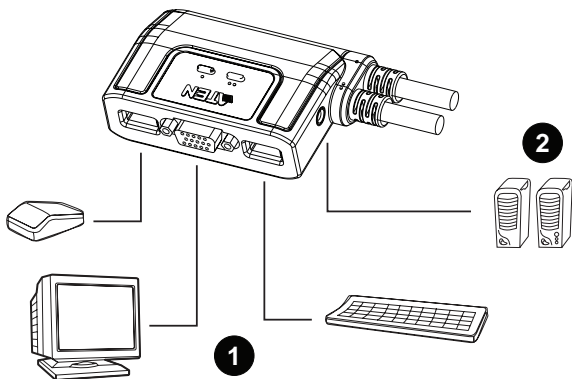

HOTKEY PORT ACCESS

INVOKING HOTKEY MODE

The CS-62U provides an extensive, easy-to-use, hotkey function that makes it convenient to control and configure your KVM installation from the keyboard. With the exception of Skip Mode (see p. 9), all hotkey operations begin by invoking Hotkey Mode (HKM).

To invoke HKM, do the following:

1. Press and hold down the **Num Lock** key
2. Press and release the **minus** key
3. Release the **Num Lock** key

- Note**1. The minus key must be released within one half second, otherwise Hotkey invocation is canceled.
2. There is an alternative key combination to invoke HKM. See p. 10 for details.

When HKM is active, the Caps Lock, and Scroll Lock LEDs flash in succession to indicate that HKM is in effect. They stop flashing and revert to normal status when you exit HKM.

When HKM is active, ordinary keyboard and mouse functions are suspended - only Hotkey compliant keystrokes and mouse clicks (described in the sections that follow), can be input.

At the conclusion of some hotkey operations, you automatically exit hotkey mode. With some operations, you must exit manually. To exit HKM manually, press the **Esc** key, or the **Spacebar**.

HOTKEY PORT ACCESS

Hotkey Port Access allows you to select which computer has the KVM focus. The CS-62U provides the following Hotkey Port Access features:

- ◆ Selecting the Active Port
- ◆ Auto Scan Mode
- ◆ Skip Mode

Selecting the Active Port:

You can bring the KVM focus to either computer with the following hotkey combination:

1. Invoke HKM (see p. 7).
2. Press and release the computer's port number (1 or 2).
3. Press [Enter].

The KVM focus switches to the computer connected to the port you just specified, and you automatically exit Hotkey Mode.

Auto Scan Mode:

The CS-62U's Auto Scan feature automatically switches the KVM focus between the two computers at regular 5 second intervals so that you can monitor their activity without having to take the trouble of switching yourself. To start auto scanning:

1. Invoke HKM (see p. 7)
2. Press and release the **A** key

Once scanning begins, it continues until you press [Esc] or [Spacebar] to exit Auto Scan Mode. The Port that is active at the time scanning stops remains active.

- Note:**
1. While Auto Scan Mode is in effect, ordinary keyboard and mouse functions are suspended. You must exit Auto Scan Mode by pressing [Esc] or [Spacebar] in order to regain normal control of their use.
 2. Pressing [Esc] or [Spacebar] exits both Auto Scan Mode and Hotkey Mode.

Skip Mode:

Skip Mode is a shortcut method for port switching. It allows you to hotkey toggle the KVM focus between the two computers without having to invoke Hotkey Mode.

To perform a skip, simply tap the **Scroll Lock** key twice. When you do this the KVM focus switches from its current port, to the other one.

- Note:** The Skip Mode activation key can be changed to the **Ctrl** key (see p. 10 for details).

HOTKEY CONFIGURATION

ALTERNATE INVOCATION KEYS

An alternate set of Hotkey Invocation keys is provided in case the default set conflicts with programs running on the computers.

To switch to the alternate Hotkey Invocation set, do the following:

1. Invoke HKM (see p. 7)
2. Press and release the **H** key

The Hotkey Invocation keys become the Ctrl key (instead of Num Lock) and the F12 key (instead of minus).

Note: This procedure is a toggle between the two methods. To revert back to the original Hotkey Invocation keys, invoke HKM, then press and release the **H** key again.

ALTERNATE SKIP MODE KEYS

The Skip Mode activation method can be changed from tapping the Scroll Lock key twice to tapping the Ctrl key twice ([Ctrl] [Ctrl]). To change the Skip Mode activation method, do the following:

1. Invoke HKM (see p. 7)
2. Press and release the **T** key

Note: This procedure is a toggle between the two methods. To revert back to the original [Scroll Lock] [Scroll Lock] method, invoke HKM, then press and release the **T** key again.

PLATFORM / LANGUAGE SETUP

The default port settings are for a PC Compatible operating platform, and US English keyboard language code. You can change these by bringing the KVM focus to the port you want to change and using the hotkey combinations shown below.

The Hotkey entry method is as follows:

1. Invoke HKM (see p. 7)
2. Press and release the appropriate Function key (see table).

After completing a setting, you automatically exit HKM.

Key	Operation
[F1]	Sets the PC Compatible keyboard operating platform.
[F2]	Sets the Mac keyboard operating platform.
[F3]	Sets the Sun keyboard operating platform.
[F7]	Sets a Generic keyboard operating platform.
[F10]	Automatically detects and sets the keyboard operating platform.
[F6] [nn] [Enter]	Sets the keyboard language layout. Where nn is a two digit number that represents the keyboard language code (see the table on p. 15).

MISCELLANEOUS

Hotkeys are also used to print out the current settings for a port, as well as to reset the USB. The Hotkey entry method is as follows:

1. Invoke HKM (see p. 7)
2. Press and release the appropriate Function key (see table).

Key	Operation
[F4]	Prints out the current hotkey, keyboard operating platform, and language code settings.
[F5]	Performs a USB reset

RESTORE DEFAULTS

To restore the CS-62U's settings to their default values:

1. Invoke HKM (see p. 7).
2. Press and release the **R** key.
3. Press [Enter]

The CS-62U's default settings are the following:





Hotkey Invocation	[Num Lock] [-]
Skip Mode Activation	[Scroll Lock] [Scroll Lock]
Keyboard Platform	Auto
Keyboard Language	English

KEYBOARD EMULATION

SUN KEYBOARD

The PS/2 (101/104) key keyboard can emulate the functions of the Sun keyboard when the Control key [Ctrl] is used in conjunction with other keys. The corresponding functions are shown in the table below.





Note: When using [Ctrl] combinations, press and release the **Ctrl** key, then press and release the activation key.

PS/2 Keyboard	Sun Keyboard
[Ctrl] [T]	Stop
[Ctrl] [F2]	Again
[Ctrl] [F3]	Props
[Ctrl] [F4]	Undo
[Ctrl] [F5]	Front
[Ctrl] [F6]	Copy
[Ctrl] [F7]	Open
[Ctrl] [F8]	Paste
[Ctrl] [F9]	Find
[Ctrl] [F10]	Cut
[Ctrl] [1]	
[Ctrl] [2]	
[Ctrl] [3]	
[Ctrl] [4]	
[Ctrl] [H]	Help

MAC KEYBOARD

The keyboard emulation mappings from the Mac keyboard to the PS/2 keyboards (101 key and 104 key), are listed in the table below.

Note: When using key combinatons, press and release the first key (Ctrl or Alt), then press and release the activation key.

PS/2	Mac Keyboard
[Shift]	Shift
[Ctrl]	Ctrl
[Win]	
[Ctrl] [1]	
[Ctrl] [2]	
[Ctrl] [3]	
[Ctrl] [4]	
[Alt]	L Alt/Option
[Prt_Sc]	F13
[Scroll Lock]	F14
[Desktop Menu]	=
[Enter]	Return
[Back Space]	Delete
[Ins]	Help
[Ctrl] [Win]	F15

APPENDIX

LED DISPLAY TABLE

Activity	Indication
Off	Port is not selected.
On (Steady)	Port is connected to an active computer.
Flashing (On and Off equal)	Port is connected to an active computer and is being accessed in Auto Scan mode.

KEYBOARD LANGUAGE CODES

Language	Code
US English	33
French	08
Japanese	15

TROUBLESHOOTING

Symptom	Possible Cause	Action
Keyboard and/or Mouse Not Responding	Loose cables.	Check cable connections to make sure they are completely seated in their sockets.
	Keyboard/Mouse needs to be reset.	Unplug the keyboard/mouse from the Console Keyboard Port, then plug it back in.
	Switch needs to be reset	Turn off the computers. Unplug the KVM cables. Wait five seconds; then plug the cables back in and turn the computers on.
	Switch is in Auto Scan Mode.	Press the [Spacebar] to exit Auto Scan Mode.
	Selected port connects to a powered Off computer.	Resend the Hotkey command selecting a port that has a powered On computer attached.
	Hotkey sequence input incorrectly.	Resend the Hotkey command - press and release each key in the sequence individually.
Video Problems	Resolution and/or Bandwidth set too high.	Select a lower resolution and/or bandwidth.

SPECIFICATIONS

Function		Specification
Computer Connections		2
Port Selection		Hot Keys
LEDs	Selected	2
Console Connectors	Keyboard	1 x Type A USB port
	Mouse	1 x Type A USB port
	Video	1 x HDB-15 female
	Audio	1 x Stereo earphone jack
KVM Cable Connectors	Keyboard & Mouse	1 x Type A USB plug
	Video	1 x HDB-15 - male
	Audio	1 x Stereo earphone plug
Scan Interval		5 Seconds (Default)
Operating Temperature		0 - 50° C
Storage Temperature		-20 - 60° C
Humidity		0 - 80% RH Noncondensing
Housing		Plastic
Weight		0.38 kg
Dimensions (L x W x H)		8.1 x 6.9 x 2.6 cm

LIMITED WARRANTY

IN NO EVENT SHALL THE DIRECT VENDOR'S LIABILITY EXCEED THE PRICE PAID FOR THE PRODUCT FROM THE DIRECT, INDIRECT, SPECIAL, INCIDENTAL OR CONSEQUENTIAL DAMAGES RESULTING FROM THE USE OF THE PRODUCT, DISK OR ITS DOCUMENTATION.

The direct vendor makes no warranty or representation, expressed, implied, or statutory with respect to the contents or use of this documentation, and specially disclaims its quality, performance, merchantability, or fitness for any particular purpose.

The direct vendor also reserves the right to revise or update the device or documentation without obligation to notify any individual or entity of such revisions, or update. For further inquires please contact your direct vendor.